

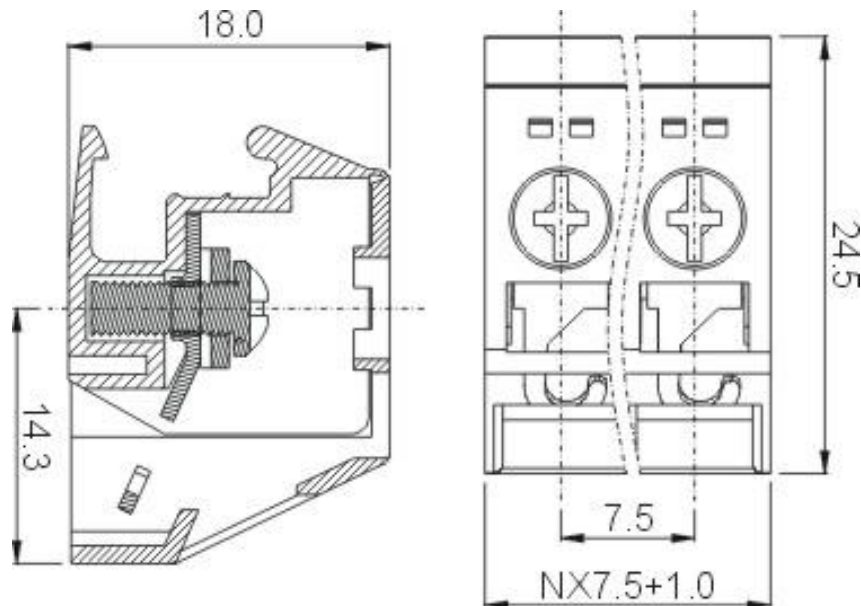





TS2.5

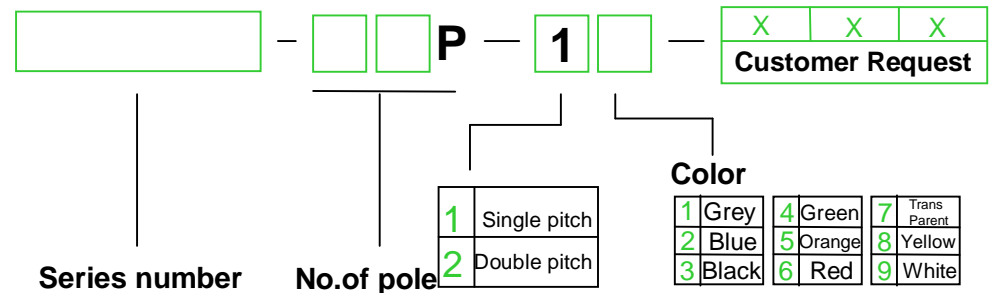

APPROVAL		
Electrical		
Standard	UL	IEC
Rated voltage	300V	250V
Rated current	10A	24A
Wire range	24-14AWG	0.5-2.5mm ²
Withstanding voltage	AC2000V/1Min	
Mechanical		
Torque	0.5Nm(4.4Lb-In)	
Ambient temperature	-40°C~+105°C	
Strip length	8-10mm	
Dimensions		
Pitch	7.5mm(.295")	
Poles	2P-3P	
Material		
Housing	PA66,UL94V-0	
Screws	M3, Steel,Cr ³⁺ Zn plated	
Contact	Copper, Tin plated	

HOW TO ORDER :

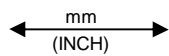

	 DEGSON ELECTRONICS CO., LTD.
	NAME TS2.5